

S500-A70 Dimensions & Wiring Diagrams

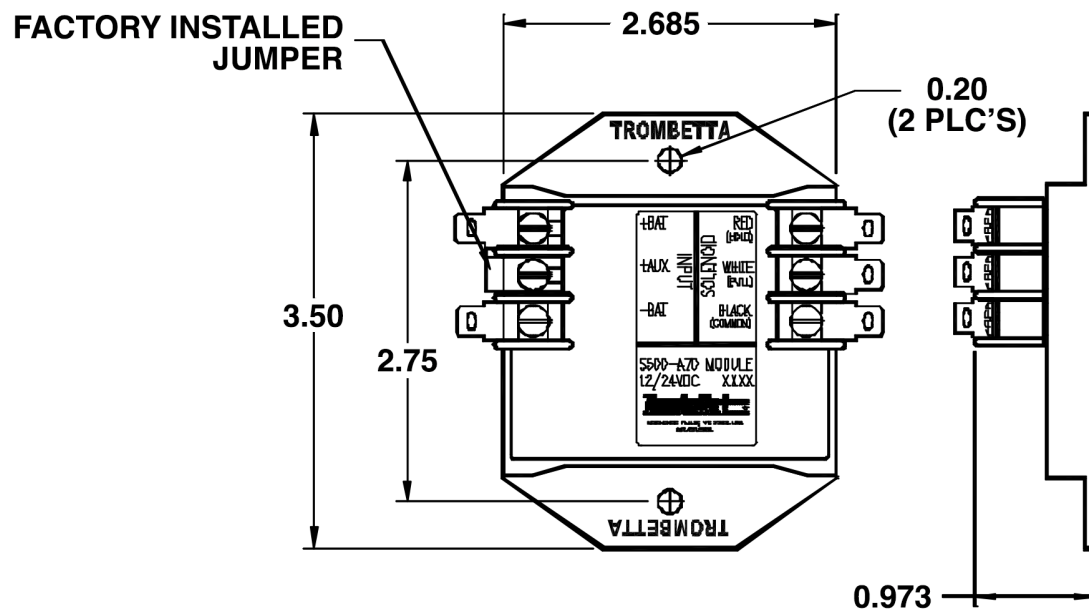

Figure 1 shows a typical wiring diagram when used with a (2) section coil solenoid, 12V or 24V. Figure 2 shows a typical wiring diagram when used with a (1) section coil solenoid, 12V or 24V. Trombetta recommends that a properly sized fuse is used, the size of this fuse is dependent on the solenoid model used. Please call or email Trombetta for assistance in selection of the proper size fuse.

Dimensions: (inches)



NOTE: When using a S500-A70 module all of the solenoid connections must connect to the module as shown.

Do not connect any of the solenoid leads to another ground point in the system.

Wiring Diagrams:

Figure 1

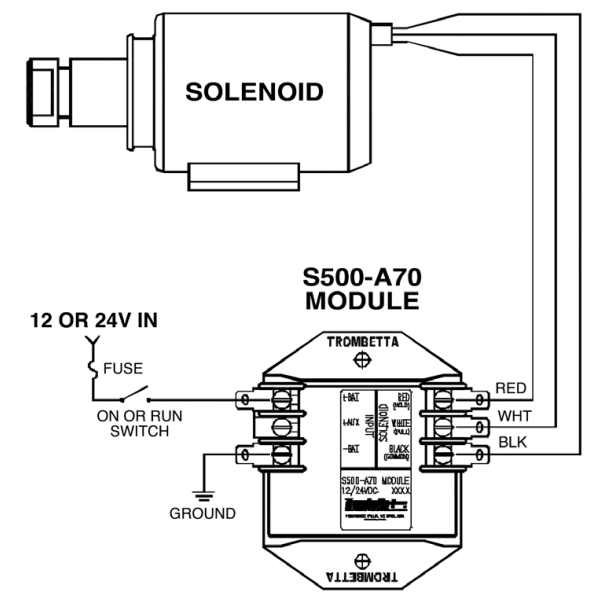
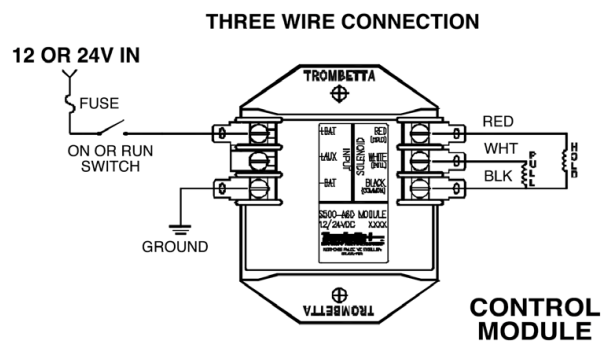

Figure 2

